

LED Component

SUPER FLUX LED LAMP

Part No	Emit Color	λ P (nm)	Lens Type	Iv(mcd)		Viewing Angle 2θ1/2	Drawing
				Min	Typ.		

7.62*7.62*3.5MM, flat round top, SUPER FLUX LED LAMP

Part No	Emit Color	λ P (nm)	Lens Type	Iv(mcd)		Viewing Angle 2θ1/2
Part No	Emit Color	λ P (nm)		Min	Typ.	
BL-FL760RLRC	Ultra Red	660	Water Clear	600	1000	160
BL-FL760RLEC	Ultra Orange	630		800	1500	
BL-FL760RLYC	Ultra Yellow	590		600	1300	
BL-FL760RLGC	Ultra Green	574		200	700	
BL-FL760RPGC	Ultra Pure Green	525		1000	5000	
BL-FL760RBGC	Ultra Bluish Green	505		800	4000	
BL-FL760RLBC	Ultra Blue	470		800	2000	
BL-FL760RLWC	Ultra White	/		1000	5000	

BL-FL760Rxx

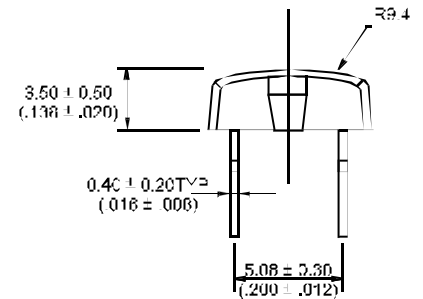
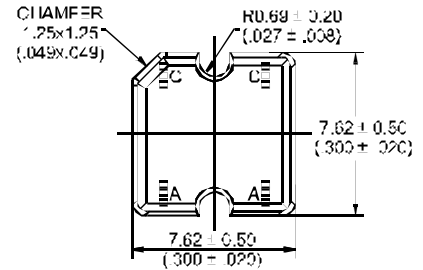

BL-FL7600xx

7.62*7.62*2.5MM, flat top, SUPER FLUX LED LAMP

Part No	Emit Color	λ P (nm)	Lens Type	Iv(mcd)		Viewing Angle 2θ1/2
Part No	Emit Color	λ P (nm)		Min	Typ.	
3L-FL7600URC	Ultra Red	660	Water Clear	600	1000	100
3L-FL7600OFC	Ultra Orange	630		800	1500	
3L-FL7600UYC	Ultra Yellow	590		600	1300	
3L-FL7600UGC	Ultra Green	574		200	700	
3L-FL7600PGC	Ultra Pure Green	525		1000	5000	
3L-FL7600BGC	Ultra Bluish Green	505		800	4000	
3L-FL7600UBC	Ultra Blue	470		800	2000	
3L-FL7600UWC	Ultra White	/		1000	5000	

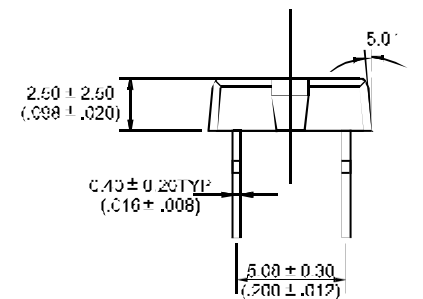
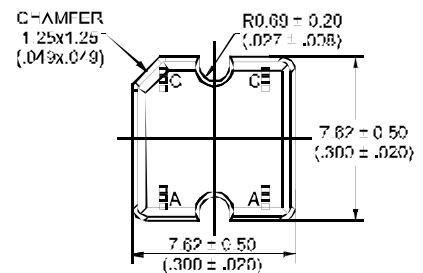

LED Component

SUPER FLUX LED LAMP

Part No	Emit Color	λ_p (nm)	Lens Type	Iv(mcd)		Viewing Angle 2D1/2	Drawing
				Min	Typ.		

7.62*7.62*5.0MM, 5mm high power, SUPER FLUX LED LAMP

Part No	Emit Color	λ_p (nm)	Lens Type	Iv(mcd) Min	Iv(mcd) Typ.	Viewing Angle 2D1/2
BL-FL7615URC	Ultra Red	650	Water Clear	1000	3000	100
BL-FL7615UEC	Ultra Orange	630		2500	4500	
BL-FL7615UYC	Ultra Yellow	590		2000	4200	
BL-FL7615UGC	Ultra Green	571		600	2100	
BL-FL7615PGC	Ultra Pure Green	525		3000	5000	
BL-FL7615BGC	Ultra Bluish Green	505		2400	2000	
BL-FL7615UBC	Ultra Blue	470		2400	6000	
BL-FL7615UWC	Ultra White	/		3000	2000	

BL-FL7615

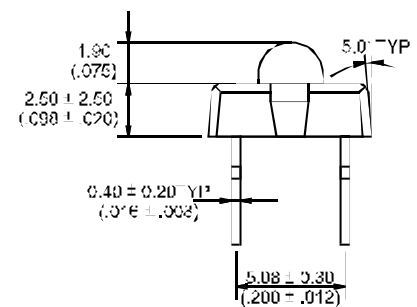
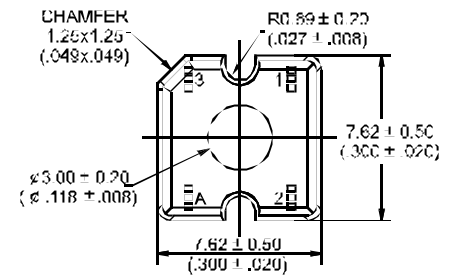

7.62*7.62*4.0MM, 4MM Cylindrical, Inverted Cone SUPER FLUX LED LAMP

Part No	Emit Color	λ_p (nm)	Lens Type	Iv(mcd) Min	Iv(mcd) Typ.	Viewing Angle 2D1/2
BL-FL7644URC	Ultra Red	660	Water Clear	200	800	140
BL-FL7644UEC	Ultra Orange	630		180	900	
BL-FL7644UYC	Ultra Yellow	590		300	900	
BL-FL7644UGC	Ultra Green	571		400	700	
BL-FL7644PGC	Ultra Pure Green	525		600	3000	
BL-FL7644BGC	Ultra Bluish Green	505		500	2800	
BL-FL7644UBC	Ultra Blue	470		500	3000	
BL-FL7644UWC	Ultra White	/		500	3000	

BL-FL7644xx

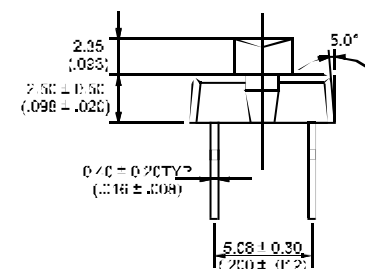
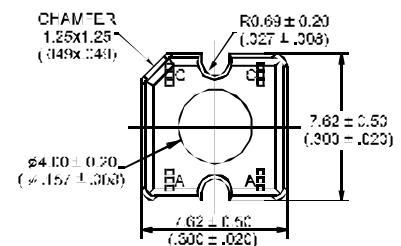

LED Component

SUPER FLUX LED LAMP

Part No	Emit Color	λ P (nm)	Lens Type	lv(mcd)		Viewing Angle 2θ1/2	Drawing
				Min	Typ.		

7.62*7.62*1.7MM, 3MM Elliptical head SUPER FLUX LED LAMP

Part No	Emit Color	λ P (nm)	Lens Type	Min	Typ.	Viewing Angle
BL-FL7653URC	Ultra Red	660	Water Clear	100	600	30/90
BL-FL7653UEC	Ultra Orange	630		150	750	
BL-FL7653UYC	Ultra Yellow	590		200	800	
BL-FL7653UGC	Ultra Green	574		300	550	
BL-FL7653PGC	Ultra Pure Green	525		600	2800	
BL-FL7653BGC	Ultra Bluish Green	505		500	2500	
BL-FL7653UBC	Ultra Blue	470		500	2800	
BL-FL7653UWC	Ultra White	/		500	2500	

BL-FL7653xx

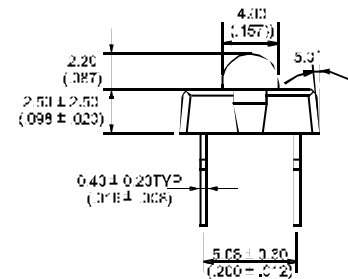
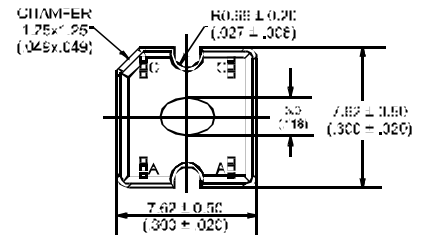

BL-FL7660xx

7.62*7.62*4.0MM, 3MM ROUND SUPER FLUX LED LAMP

Part No	Emit Color	λ P (nm)	Lens Type	Min	Typ.	Viewing Angle
BL-FL7660JRC	Ultra Red	660	Water Clear	600	1000	75
BL-FL7660JEC	Ultra Orange	630		800	1500	
BL-FL7660JYC	Ultra Yellow	590		600	1300	
BL-FL7660JGC	Ultra Green	574		200	700	
BL-FL7660PGC	Ultra Pure Green	525		1000	5000	
BL-FL7660BGC	Ultra Bluish Green	505		800	4000	
BL-FL7660JBC	Ultra Blue	470		800	2000	
BL-FL7660JWC	Ultra White	/		1000	5000	

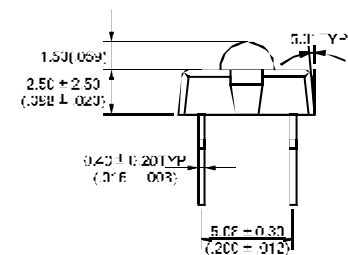
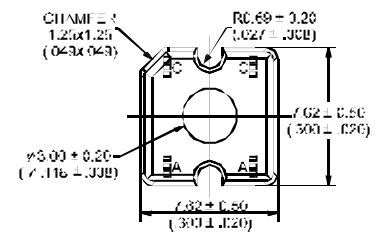

LED Component

SUPER FLUX LED LAMP

Part No	Emit Color	λ P (nm)	Lens Type	Iv(mcd)		Viewing Angle 2θ1/2	Drawing
				Min	Typ.		

7.62*7.62*5.0MM, 5MM ROUND SUPER FLUX LED LAMP

Part No	Emit Color	λ P (nm)	Lens Type	Iv(mcd)	Iv(mcd)	Viewing Angle 2θ1/2
				Min	Typ.	
BL-FL7680JRC	Ultra Red	660	Water Clear	600	1500	80
BL-FL7680JFC	Ultra Orange	630		800	1800	
BL-FL7680JYC	Ultra Yellow	580	Water Clear	600	1600	80
BL-FL7680JGC	Ultra Green	574		200	1000	
BL-FL7680PGC	Ultra Pure Green	525	Water Clear	1000	6000	80
BL-FL7680BGC	Ultra Bluish Green	505		800	4800	
BL-FL7680JBC	Ultra Blue	470	Water Clear	800	5000	80
BL-FL7680JWC	Ultra White	/		1000	6000	

BL-FL7680xx

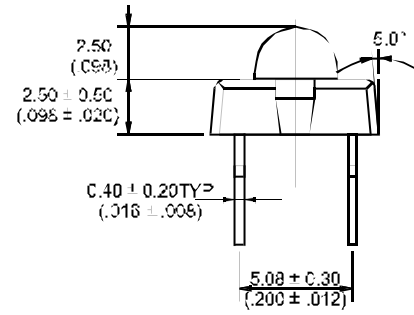
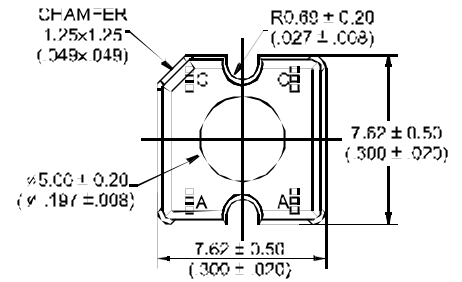

7.62*7.62*5.0MM, 5MM ROUND SUPER FLUX LED LAMP, RGB type

Part No	Emit Color	λ P (nm)	Lens Type	Iv(mcd)	Iv(mcd)	Viewing Angle 2θ1/2
				Min	Typ.	
BL-FL7680RCBC	Ultra Orange	630	Water Clear	250	400	80
	Ultra Pure Green	525		800	1200	
	Ultra Blue	470		250	400	

